



Agilent 8510-13

Measuring Noninsertable Devices

Product Note

A new technique for measuring components using the 8510C Network Analyzer



Agilent Technologies
Innovating the HP Way

Introduction

The majority of devices used in real-world microwave systems are noninsertable because of the connectors employed. In the past, these devices were theoretically not measurable meaning that fully traceable and verifiable data could not be provided. Now the Agilent Technologies 8510C with an S-parameter test set offers a new technique that provides accuracy rivaling the best insertable device measurements. This note reviews various methods used to calibrate the network analyzer for measurement of noninsertable devices and compares the results and uncertainties of each method.

As shown in Figure 1, for a test device to be insertable, both connectors must be of the same connector family, with one connector male, and the other female. When the test device is insertable, then the measurement ports can be connected together to establish the thru connection during transmission calibration. The configuration of the measurement test setup need not be changed between transmission calibration and actual measurement of the test device.

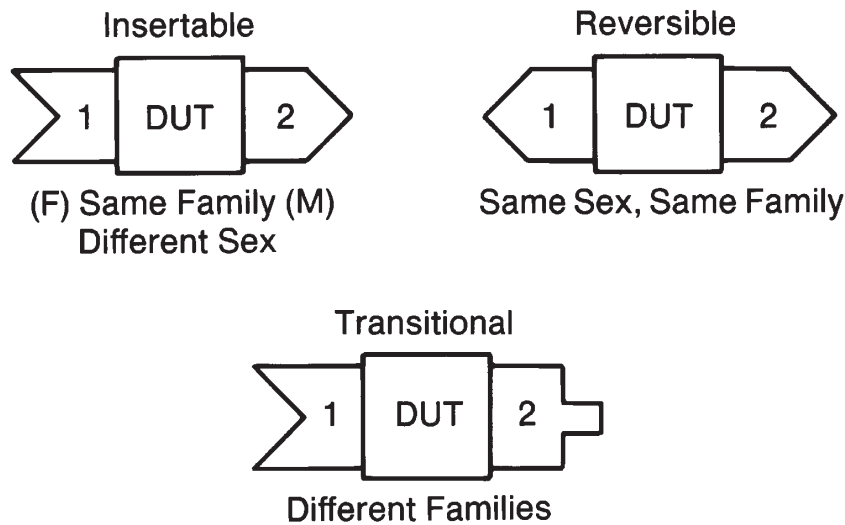

Figure 1. Classes of Device Under Test (DUT). For insertable devices, Port 1 connector type will mate with Port 2 connector type. For reversible devices, the same sex of the same connector family are used on both Port 1 and Port 2. Transitional devices use connectors of different families on Port 1 and Port 2.

There are two general types of noninsertable test devices. The first, and probably the most prevalent, is the reversible type of device. A reversible device is one that has both connectors of the same family and sex. Note that devices with hermaphroditic connectors, like precision 7 mm, are both insertable and reversible. The second category of noninsertable devices is the transitional type. With transitional devices, the connectors are of different families, such as coaxial and waveguide.

In terms of measurement accuracy and convenience, it would be desirable if all purely coaxial microwave modules and cables were configured to be insertable. In systems using coaxial cable to interconnect the modules and subsystems, it is common for cables to use a male connector on both ends and for the modules to use female connectors on all their ports. Often the designer is faced with the same measurement problem due to the fact that the device by nature is not insertable because it is a coaxial to waveguide transition. These non-insertable configurations lead to testing problems because the device under test measurement specifications are seriously compromised.

Why poorer specifications? Simply, the device cannot be inserted in the measurement system using the identical configuration in which the measuring system alone was calibrated. The difference in system configuration between calibration and measurement produces an uncertainty in the accuracy of the results that can only be treated as a random error having an unknown magnitude and phase. This must result in an increase in the specification guardband causing unnecessary rejects, increased testing and analysis time, and ultimately an increase in the cost of the device.

Accuracy enhancement

At microwave frequencies systematic effects such as leakage, test port mismatch, and frequency response will produce uncertainties in the measured data. However, in a stable measurement environment these effects are repeatable and can be measured by the network analyzer. This process is called measurement calibration. During measurement calibration a series of known devices (standards) are connected to the test ports and measured. The systematic effects are determined as the difference between the measured and the known, or modeled, responses of the standards. Now the device under test is measured. The accuracy enhancement algorithm uses an error model of the network analyzer system to mathematically relate these errors to the results of the device measurement and thus obtain values for the actual responses of the DUT.

Under ideal conditions, with perfectly known standards, systematic effects would be completely characterized and removed. The accuracy to which these standards are known establishes how well these systematic errors can be characterized and removed. In fact, a well established figure of merit for a calibrated system is the magnitude of the residual systematic errors. These residual errors are the portion of the uncorrected systematic errors that remain because of imperfect modeling of the actual response of the calibration standards.

Error model

Vector error correction techniques can greatly reduce the effects of directivity, crosstalk, source match, and frequency response errors as well as the mismatch uncertainties caused by the vector interaction of the input and output impedance of the DUT with the imperfect source and load match of the measuring system. The Agilent 8510 12-term calibration and measurement model provides the highest accuracy in common use today (Figure 2). This 12-term error model is used in both the FULL 2-PORT and the TRL 2-PORT calibration types offered in the 8510C.

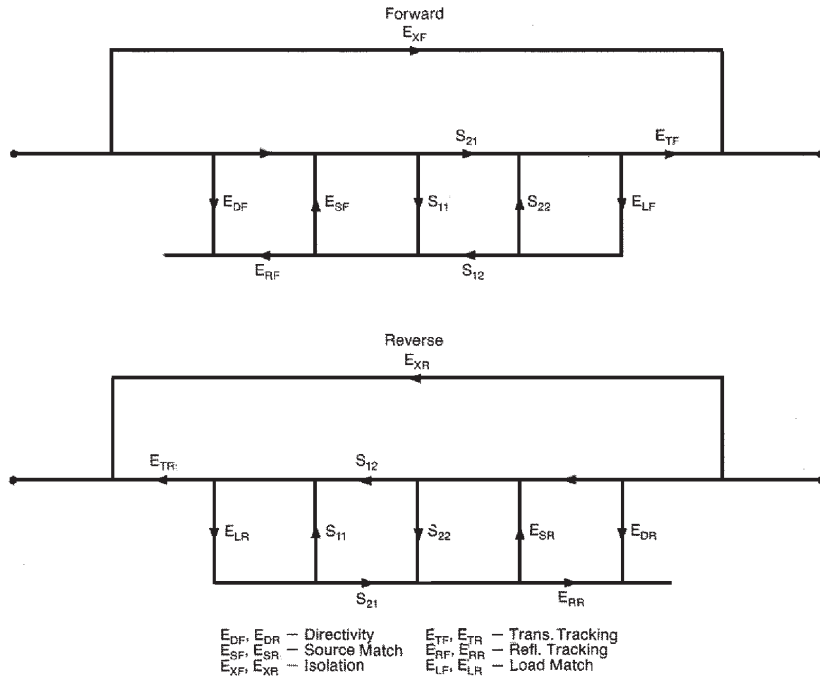

Figure 2. 12-Term Error Model. The most sophisticated 12-term error model is required to account for transmission and reflection signal path response and leakages, source and load mismatch effects in transmission measurements, and the effect of an imperfect termination in reflection measurements.

The ideal case

The ideal case for measurement of a 2-port device provides best accuracy and complete traceable and verifiable data (Figure 3). This calibration procedure uses an S-parameter test set to measure an insertable device. Steps 1 and 2 measure separate error terms for directivity, source match, and reflection signal path frequency response for both test ports. Transmission isolation is measured with both ports terminated. In step 3, the test ports are connected together to make the thru and then measure separate error terms for forward and reverse load match and transmission signal path frequency response.

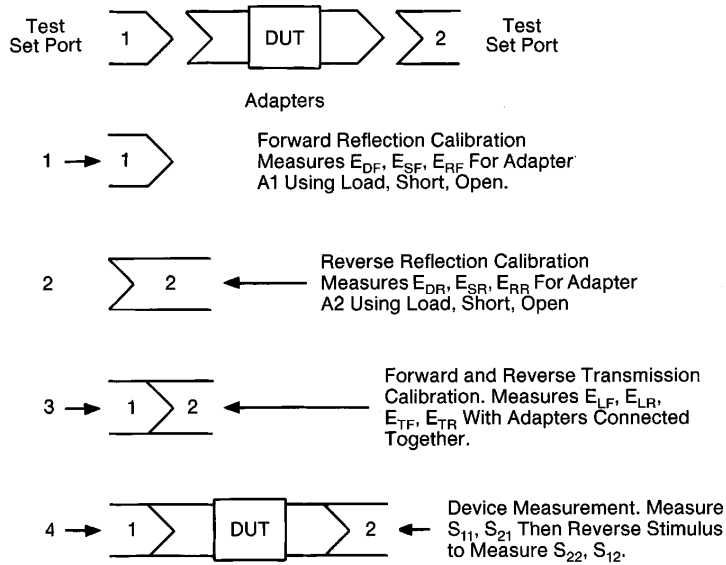

Figure 3. Ideal Case-2-Port Cal. Measurement of insertable device using an S-parameter (two-path) test set is the ideal case. All error terms can be measured with the correct test port connectors in place, and the device under test does not require physical reversal.

Since the Port 1 and Port 2 connection to accomplish the thru is the same as will be used during the measurement, all error coefficients can be obtained directly.

With the device connected, step 4, the stimulus is applied to Port 1 and the forward parameters, S_{11} and S_{21} , are measured. Then the stimulus is applied to Port 2 and the reverse parameters, S_{22} and S_{12} , are measured. These measured values, along with the error terms, are used in the accuracy enhancement algorithm to find the actual device parameters with greatly reduced uncertainty. In this application the thru does not actually represent any specific device, or the special case of an absence of any device at all. This is a basic principle of transmission measurement calibration. The transmission reference is a zero-length, zero-loss transmission line. Essentially, Port 1 of the test set is connected directly to Port 2 of the test set, then the ports are separated and the device to be tested is inserted. Past practice has allowed complete performance verification with verifiable and traceable specifications only when this is the case.

If the device under test is not insertable, then it is necessary to use some sort of thru device in order to accomplish the connection for measurement of transmission response and load match. This is the problem. With the 12-term calibration procedure, the thru connection is used to measure the transmission signal path frequency response and the impedance of the return port. But what good does it do to measure the frequency response and load match error terms when the wrong adapter is installed? During calibration, the thru device is measured but it is removed or changed for the actual device measurement.

Due to improvements in the hardware and calibration techniques, there are ways to achieve measurement results with accuracy very near to that which is achievable with the ideal insertable case. Now we will examine common techniques for measurement of noninsertable devices and the new 8510C adapter removal method.

Case 1—Swap equal adapters

An acceptable technique for coaxial measurements involves switching between high quality matched adapters for the transmission part of the calibration. Figure 4 shows this technique for measurement of a reversible device. First, one of the correct adapters (A1 or A2, which can mate with the device under test) is switched with a wrong adapter (A3, which mates with A1 or A2) and the transmission characteristics are measured. Then the correct adapter is installed and the reflection characteristics of the ports are measured. This sequence of measuring the transmission path first, then reflection, minimizes the number of connections and disconnections required, thus improving accuracy and repeatability. Finally, the device is connected and measured. If the switched adapters have equal reflection and transmission characteristics, and the adapter can be switched with repeatable results, the insertion loss measurement uncertainty can be very small. The Agilent Type-N calibration kit includes matched 7-mm-to-Type-N-male and 7-mm-to-Type-N-female adapters which are designed especially for this technique.

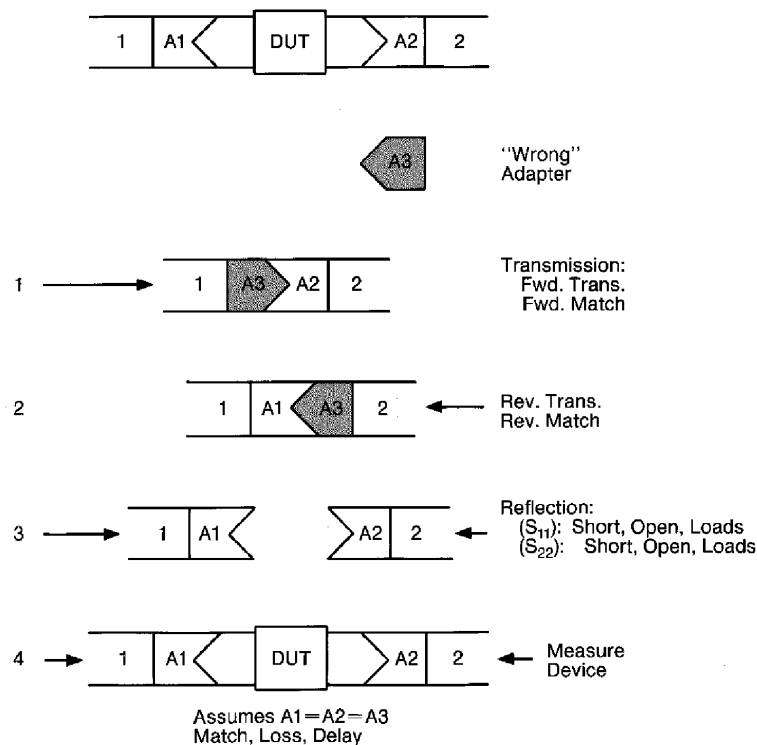

Figure 4. Swap Equal Between-Series Adapters. The adapters are switched for transmission calibration then the correct adapter set is installed for reflection calibration and to connect the DUT. Surprisingly accurate measurement results are possible when the adapters are exactly equal in length, impedance, and loss.

A better solution, particularly when measuring reversible SMA, 3.5-mm or 2.4-mm devices, involves switching equal in-family adapters during the measurement calibration. Figure 5 shows this sequence. Adapter B1 is installed for transmission calibration, then B2 is installed for reflection calibration and measurement of the device.

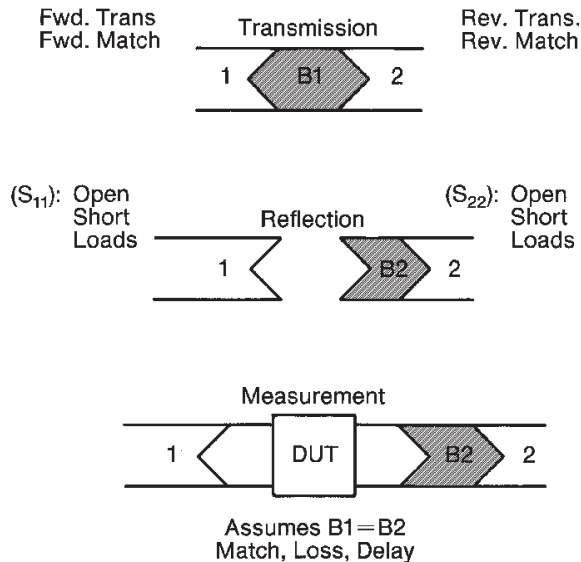

Figure 5. Swap Equal In-Family Adapters. Because the in-family adapters are generally less complex to produce than between-series adapters. Chances are that the in-family adapters will be more equal thus producing less measurement uncertainty.

The success of this technique depends highly on the ability to achieve repeatable connections, as well as how equal the adapters are. Equal in this case means equal in match, Z_0 , as well as in insertion loss and electrical delay. If the switched adapters are equal and the connections are repeatable, then the test set is essentially the same during measurement calibration and measurement and there is no additional uncertainty due to incorrect load match or transmission tracking error coefficients.

The Agilent 3.5-mm and 2.4-mm calibration kits contain three of these in-family adapters just for this purpose. These components are designed to be as equal as possible in Z_0 , insertion loss, and electrical delay, and are manufactured to extremely close tolerances. When matched adapters like these are available, this technique is potentially better than swapping between-series adapters because the important characteristics can be controlled precisely with both connectors being of the same family.

If the adapters are not equal, these techniques ignore the insertion loss, mismatch, and electrical length differences between the adapters. This leads to measurement errors because the differences in loss and match directly affect the measured loss and impedance of the device under test. Also, any difference in electrical length affects the measured electrical length, thus phase and group delay, of the DUT. If the adapters are not exactly equal, use of the higher accuracy 12-term model will often lead toward greater uncertainty than if we had employed a simpler error model.

Case 2—Modeling the non-zero thru

If the characteristics of the thru device are known, acceptable measurements can be made by modeling the effect that the thru device has upon measurement of the system errors. In this method the difference between the connection used for transmission calibration and for connection of the DUT is modeled into a delay/thru type standard of the calibration kit definition by specifying the insertion loss, electrical length, and impedance characteristics of the thru. If the delay/thru model is exact, then the effect of the change to the test ports is removed from the error terms.

This technique can be very effective if the magnitude, phase, and impedance of the thru connection is modeled very accurately, but may not provide sufficient correction of the actual effect of the non-zero thru upon the magnitude and phase of the forward and reverse load match terms. This will produce errors in the measurement of low loss devices.

Case 3—Complete noninsertable calibration

The most complete and effective calibration procedure for noninsertable devices is called adapter removal. This technique (Figure 6) requires an adapter that has the same connector types as the device under test and calibration standards for both connector types. The electrical length of the adapter need only be specified within $\pm 1/4$ wavelength at each frequency. The current Agilent Type-N, 3.5-mm, and 2.4-mm calibration kits are supplied with the in-family adapters already defined for use in the adapter removal procedure. In order to use any other adapter, such as a waveguide to coaxial transition, the adapter must be specified as described in the box inset, Specify the adapter, on page 11.

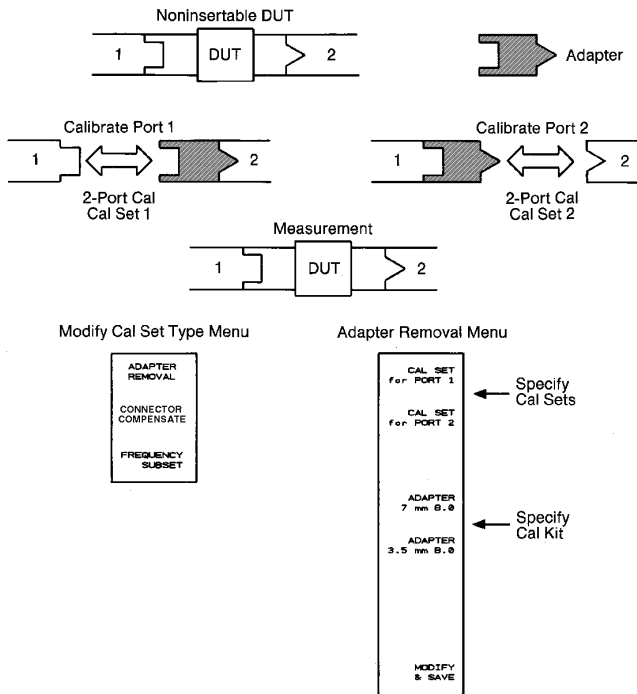

Figure 6. Adapter Removal Calibration. A 2-Port calibration (either FULL 2-PORT or TRL 2-PORT) for each port, along with knowledge of the nominal length of the adapter, allow complete removal of the effects of the adapter from the error coefficient set.

The adapter removal algorithm uses the results of the two cal sets along with the nominal electrical length of the adapter to compute the actual S-parameters of the adapter. This data is used to generate a separate third cal set in which the forward and reverse match and tracking terms are as if Port 1 and Port 2 could actually be connected. This is possible because the actual S-parameters of the adapter are measured with great accuracy, allowing the effects of the adapter to be completely removed when the third cal set is generated.

Perform the 2-port calibrations

Two 2-Port calibrations are performed, first with the adapter connected to Port 2, then with the adapter connected to Port 1. The result of each calibration is stored in a separate cal set. Note that both of these calibrations are performed using the ideal zero-length, zero-loss thru connection.

If the device has a waveguide port and a coaxial port, there is an additional consideration. For a typical waveguide calibration the **SET Z₀** function under the **CAL** menu is set to 1; for the typical coax calibration the **SET Z₀** function is set to 50. Be certain that the correct value is entered before beginning each calibration and, if the Smith chart is used, for impedance measurement at the appropriate ports of the DUT.

Modify and save the new cal set

When the calibrations are complete, press **CAL, MORE, MODIFY CAL SET**, then **ADAPTER REMOVAL**. Now press **CAL SET** for **PORT 1** and specify the cal set used to store the Port 1 calibration results; then press **CAL SET** for **PORT 2** and specify the cal set used to store the **Port 2** calibration results. Next specify the cal kit which contains the definition of the adapter by pressing the softkey labeled with the cal kit name. Finally, press **MODIFY & SAVE** then specify a separate cal set to contain the new error coefficients. The error coefficients will be computed and stored, correction is turned on, and error-corrected data is displayed.

Verify the calibration

Following the multiple calibrations and the adapter removal procedure, verify the accuracy of the calibrations and the adapter removal algorithm by measuring the adapter. Because the adapter used during calibration has been mathematically removed from the error coefficient set, the measurement should accurately represent the actual response of the adapter. This step serves as a verification of the calibration. If unexpected phase variations show up in the response of the adapter (such as shown in part B of Figure 7) it is a sign that the electrical delay of the adapter was not specified closely enough in the cal kit definition.

Fortunately, if the adapter length has not been specified correctly, it is not necessary to repeat the two 2-Port calibrations. Simply change the adapter offset delay specification in the cal kit definition to the correct value and then repeat the menu sequence under adapter removal.

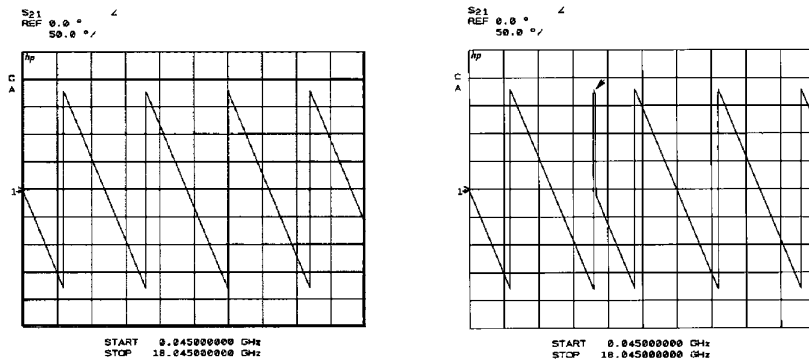

Figure 7. Measurement of Adapter After Adapter Removal. Part A shows the insertion phase of the adapter after adapter removal. Part B shows unexpected phase transitions which will be present if the electrical delay of the adapter is not specified within $\pm 1/4$ wavelength at each frequency.

Specify the adapter

It is important to recognize that the nominal electrical delay of the adapter must be known within $\pm 1/4$ wavelength at each measurement frequency. The electrical delay of the adapter must be known because the adapter removal calculations include taking a square root of a complex number. In order to determine the correct sign of the root, the algorithm uses the adapter length to place the result in the correct quadrant. The adapter's electrical length must be entered into one of the Agilent 8510 cal kit definitions.

Measure the adapter

Measure the nominal electrical delay of the adapter as follows:

1. With Port 1 configured so that the adapter may be connected, perform a simple S_{11} Response calibration at Port 1 using a short circuit.
2. Connect the adapter to Port 1 and terminate the adapter with a short circuit.
3. Measure the electrical delay of the adapter. Select **PHASE, RESPONSE MENU, ELECTRICAL DELAY**, then adjust electrical delay to achieve a flat trace. If the adapter is a waveguide device, select waveguide delay and enter the correct cutoff frequency.

One-half the measured electrical delay value is the actual nominal length of the adapter. If the short circuit used to terminate the adapter is offset, remember to subtract its electrical length from the measurement.

Modify the cal kit

Next, modify one of the cal kits to include this adapter definition as follows:

1. Select the cal kit to include the adapter definition by pressing **CAL, MORE, MODIFY <cal kit label>**.
2. Refer to the cal kit Standard Assignment table in the cal kit manual and choose an unused standard, 20 for instance. Press **DEFINE STANDARD**, then enter 20, x1, then select the standard type by pressing **DELAY/THRU**.
3. Enter the electrical delay of the adapter by pressing **SPECIFY OFF SET, OFFSET DELAY**, then entering the value for electrical delay measured above. If the adapter is a waveguide device, press **WAVEGUIDE**, then press **MINIMUM FREQUENCY** and enter the **cutoff** frequency. Press **STD OFFSET DONE**.
4. Next, enter a descriptive label for the adapter by pressing **LABEL STANDARD** then using the knob and the Title menu. Press **TITLE DONE**. Now press **STD DONE (DEFINED)**. (It is not necessary to specify any other characteristics of the adapter except Offset Delay, Minimum and Maximum Frequency, and Coax or Waveguide.)
5. Now press **SPECIFY CLASS, MORE, MORE**, then **SPECIFY: ADAPTER** and enter the standard number of the adapter, 20, x1. Press **CLASS DONE**.
6. Enter an appropriate class label by pressing **LABEL CLASS, MORE, MORE, ADAPTER** then using the Title menu.
7. Enter an appropriate label for the calibration kit by pressing **LABEL KIT** and defining the title using the Title menu.
8. Finally, press **KIT DONE (MODIFIED)** to save this new cal kit definition.

This cal kit is now ready to be used in the adapter removal procedure.

Results using adapter removal

The following plots show comparisons of results obtained with various techniques. Figure 8 is a way to verify that the adapter removal algorithm works correctly. First, part (a) shows a 7-mm beaded air line measured using the standard full 2-Port calibration. The S_{21} frequency domain magnitude is a typical response for this type of device. The S_{11} time band pass domain measurement clearly shows the internal beads that support the center conductor. Next, part (b) shows the results of two, 2-port calibrations combined using the adapter removal procedure, then the same air line is measured. Part (c) shows measurement of the 7-mm-to-7-mm adapter used in this sequence. It was made up of a 7-mm-to-3.5-mm-male adapter connected to a 3.5-mm-female-to-7-mm adapter. Notice that it has generally poorer return loss and a more complex internal structure than the air line.

(a) Frequency and Time Band Pass Results, Standard Full 2-Port Calibrations

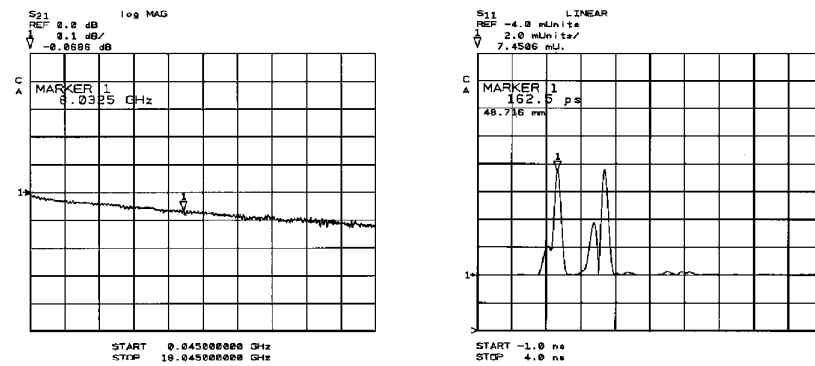

(b) Frequency and Time Band Pass Results, Adapter Removal Calibration

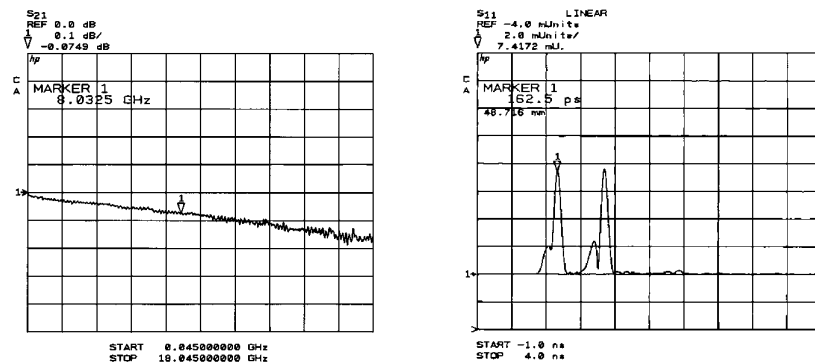

(c) Frequency and Time Band Pass Results, Adapter used in (b)

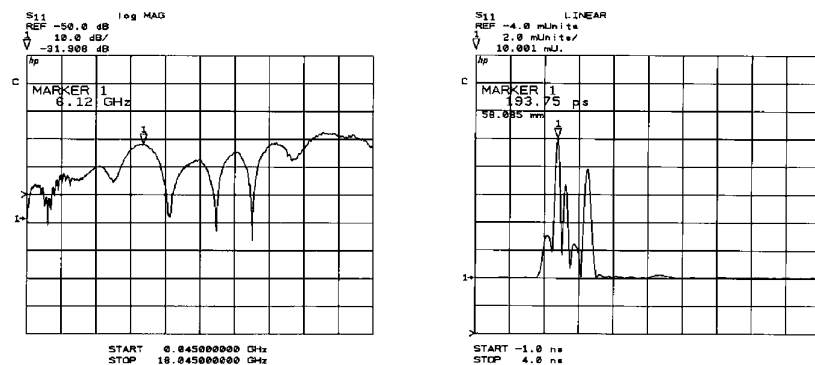

Figure 8. 7-mm Beadless Airline Comparisons. Measurements of this device using (a) the standard full 2-Port calibration and (b) the adapter removal calibration show corresponding results in both the frequency and the time domains. Very close agreement is shown even though the adapter is generally poorer quality than the device under test. Part (c) shows the S_{11} frequency and time band pass domain measurements of the adapter.

Figure 9 compares measurements of a low-loss 3.5-mm reversible device made by connecting 7-mm-to-3.5-mm-female adapters to the air line used in Figure 8. For the first four plots, the air line is measured after switching between the very equal, high quality 3.5-mm-male-to-female and female-to-female adapters in the 85052B 3.5-mm calibration kit. In the second set of four plots, the same device is measured using the adapter removal with the 3.5-mm-female-to-female adapter. Since the test device is stable and the adapters are high quality, there are only minor differences between the two sets of results. In particular, note the difference in the time domain traces obtained using adapter removal where the load match effects are not removed as well using the swap equal adapter technique.

A technique not shown here was investigated that involved a combination of a 2-port calibration and a simpler 1-port calibration to measure and remove the adapter. Comparison of test results showed that the load match term in the reverse direction was typically 6 dB worse than the Agilent 8510C adapter removal procedure. Further investigation showed this 2-port/1-port procedure no better than using the swap adapter technique with good adapters and that the results were strongly affected when the adapter exhibited poor match. The 8510C adapter removal procedure shows no such dependence upon the adapter match.

Note that the 8510C adapter removal procedure produces a fully error-corrected measurement of the 2-port device. The measurement results of the 8510C adapter removal procedure are traceable to the extent that the calibration standards used for both of the 2-port calibrations are traceable. The actual uncertainties of the measurement after the adapter removal procedure can be determined using the standard techniques applied to 2-port calibrations. It is necessary to factor in the errors due to inaccuracies of the calibration standards once for each calibration.

In some applications the adapter removal procedure may be less convenient since two 2-port calibrations are required. However, adapter removal can provide a new level of confidence even if you choose to use the less accurate technique of swap equal adapters to measure the device under test. Because adapter removal provides an exact measurement of the adapters, you obtain a realistic value for the difference between their length, loss, and impedance. So, for measurements that do not require verifiable accuracy, adapter removal may allow you to use less accurate calibration methods in the actual device measurement but with a better idea of the actual effects of the non-zero thru.

(a) Results after Swapping Between Equal Adapters.

(b) Results after Adapter Removal Procedure.

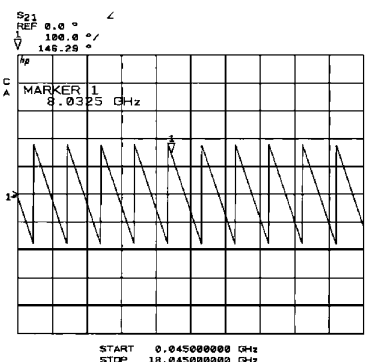
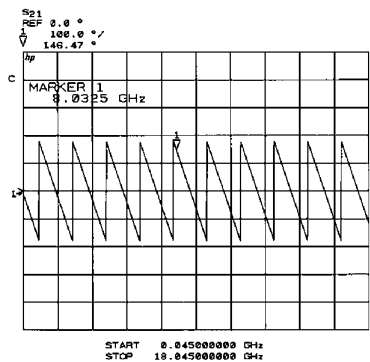
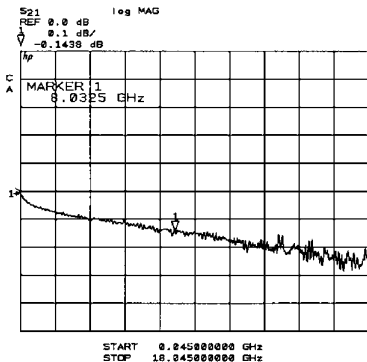
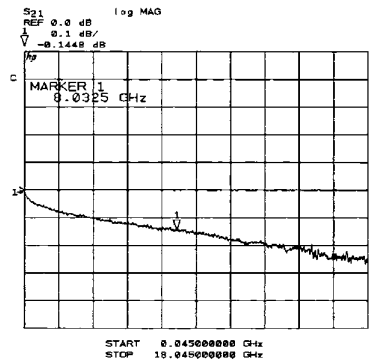
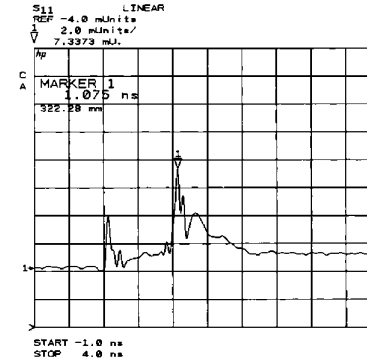
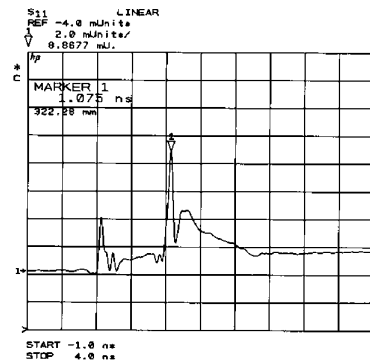
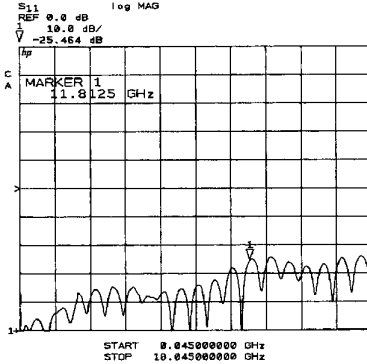
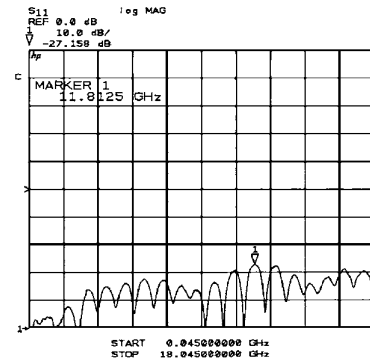

Figure 9. Comparing Calibration Methods. Comparison of results measuring a 3.5-mm reversible device (port 1 female – port 2 female) using a two-path test set: (a) shows switching between high quality adapters; (b) shows new adapter removal procedure. Since the switched adapters are equal, there is little difference between the results.

Agilent Technologies' Test and Measurement Support, Services, and Assistance

Agilent Technologies aims to maximize the value you receive, while minimizing your risk and problems. We strive to ensure that you get the test and measurement capabilities you paid for and obtain the support you need. Our extensive support resources and services can help you choose the right Agilent products for your applications and apply them successfully. Every instrument and system we sell has a global warranty. Support is available for at least five years beyond the production life of the product. Two concepts underlie Agilent's overall support policy: "Our Promise" and "Your Advantage."

Our Promise

"Our Promise" means your Agilent test and measurement equipment will meet its advertised performance and functionality. When you are choosing new equipment, we will help you with product information, including realistic performance specifications and practical recommendations from experienced test engineers. When

you use Agilent equipment, we can verify that it works properly, help with product operation, and provide basic measurement assistance for the use of specified capabilities, at no extra cost upon request. Many self-help tools are available.

Your Advantage

"Your Advantage" means that Agilent offers a wide range of additional expert test and measurement services, which you can purchase according to your unique technical and business needs. Solve problems efficiently and gain a competitive edge by contracting with us for calibration, extra-cost upgrades, out-of-warranty repairs, and on-site education and training, as well as design, system integration, project management, and other professional services. Experienced Agilent engineers and technicians worldwide can help you maximize your productivity, optimize the return on investment of your Agilent instruments and systems, and obtain dependable measurement accuracy for the life of those products.

By internet, phone, or fax, get assistance with all your test and measurement needs.

Online Assistance

www.agilent.com/find/assist

Phone or Fax

United States:
(tel) 1 800 452 4844

Canada:
(tel) 1 877 894 4414
(fax) (905) 206 4120

Europe:
(tel) (31 20) 547 2323
(fax) (31 20) 547 2390

Japan:
(tel) (81) 426 56 7832
(fax) (81) 426 56 7840

Latin America:
(tel) (305) 269 7500
(fax) (305) 269 7599

Australia:
(tel) 1 800 629 485
(fax) (61 3) 9210 5947

New Zealand:
(tel) 0 800 738 378
(fax) (64 4) 495 8950

Asia Pacific:
(tel) (852) 3197 7777
(fax) (852) 2506 9284

Product specifications and descriptions in this document subject to change without notice.

Copyright © 1999, 2000 Agilent Technologies
Printed in U.S.A. 8/00
5956-4373E



Agilent Technologies

Innovating the HP Way